

iWOW Electric Lift Height Controller Instructions

Technical specifications & Instructions for use



USER GUIDE & PROGRAMMING INSTRUCTIONS

iWOW Electric Lift Version – please note the electric Lift system offers increased height range over Pneumatic

Overall Dimensions (mm)

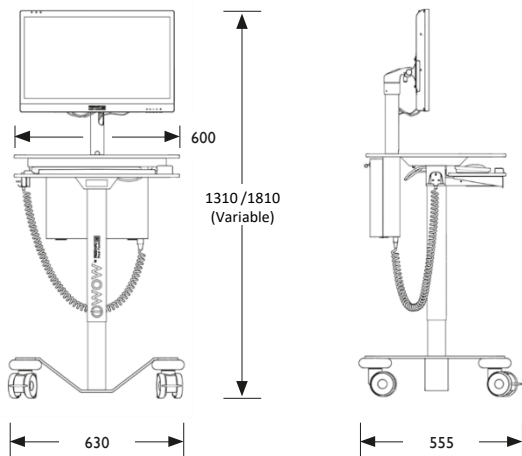

Min/Max worktop height from floor (mm)

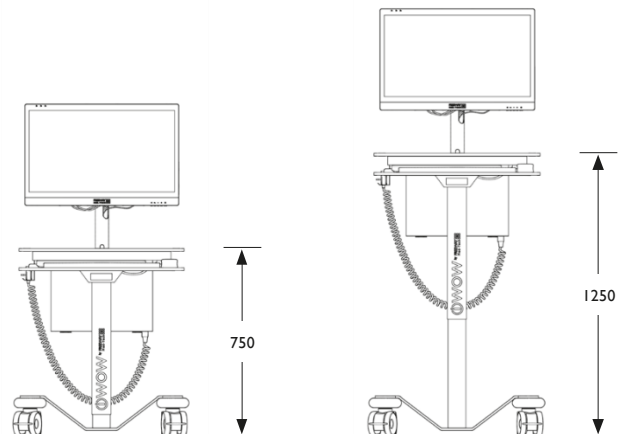

* Dimensions for guidance only – can change without notice

DPG1C

The DPG1C has three operation buttons.

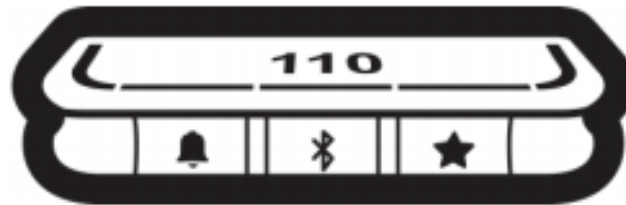

Figure 32: DPG1C operation buttons

Each button has a specific function:

Symbol	Description	Function
🔔	Reminder	Setting reminders
📶	Bluetooth®	Connecting the Desk Control™ App via Bluetooth® wireless technology
★	Favourite	Saving favourite positions

Display

The DPG1C has an OLED display, which shows the height during drive of the desk and many other texts to guide the users.

Adjusting the displayed height of the desk

If the height shown in the display is not correct, it can be adjusted.

1. Press 🔔 and the 📶 buttons on the DPG1C at the same time for five seconds and the height in the display starts to flash.
2. Tilt the DPG1C to change the displayed height without moving the desk. Tilt up to increase the displayed height, tilt down to decrease the displayed height.
3. Press any button to confirm the height or wait for 10 seconds for automatic confirmation.

Changing the measurement unit

The measurement unit shown in the display can be set to either cm or inch.

1. Press ★ and 📶 buttons on DPG1C at the same time for five seconds and the current measurement unit flashes in display.
2. When e.g. "CM" flashes in display, tilt DPG1C once to change measurement unit to inch. "INCH" now flashes in display.
3. Press any button to confirm measurement unit or wait for 10 seconds for automatic confirmation.

Operate the desk panel by tilting it.

1. Tilt and hold up DPG1C to drive desk up, press and hold down DPG1C to drive desk down.
2. Release DPG1C when you have reached your requested position.



Figure 33: Tilt and hold the DPG1C to drive the desk up

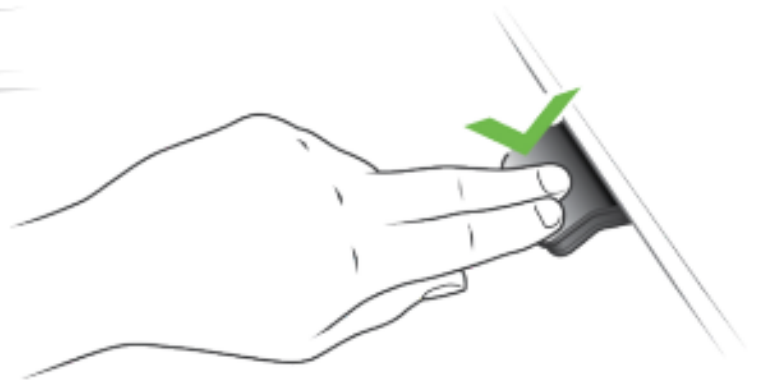

Figure 34: Press and hold the DPG1C to drive the desk down

Desk height limits

In case the desk cannot be operated in its entire span (e.g. a shelf is blocking the upwards movement or a filing cabinet is placed under the desk and blocking the downwards movement), it is possible to set an upper limit and a lower limit for the desk height.

Note:

It must always be possible to drive the desk to its minimum height in case initialisation is required. During initialisation items placed under the desk must be removed.

Setting upper limit

1. Adjust desk to maximum allowable height.
2. Press \times and tilt DPG1C up at the same time for 8 seconds until light flashes.
3. Release \times and DPG1C.

Setting lower limit

1. Adjust desk to minimum allowable height.
2. Press \times and press DPG1C down at the same time for 8 seconds until light flashes.
3. Release \times and DPG1C.

Favourite positions

Saving favourite positions 1 and 2

1. Adjust desk to a preferred position.
2. Press ★ button for two seconds.



Figure 35: Saving favourite positions

The light strip flashes white two times to indicate that saving the position is in progress. Not until the light strip becomes static white, has the position been saved. The display indicates the saved position with a ★ and a position number. The number next to the ★ indicates the order in which the positions are saved.

- First position saved: "1" is displayed next to the ★.
- Second position saved: "2" is displayed next to the ★.

If the user adjusts the desk to another position and saves this position, it will overwrite the favourite position (1 or 2) closest to the current position.

Saving favourite positions 3 and 4

1. Press ★ button shortly to make display toggle through the four favourite positions (with position ★ number next to it).
2. Toggle through these four favourite positions in display and choose which one to save current position as.

E.g. a user wants to save the current position as favourite position 3:

3. Press the ★ button and toggle to the ★ with "3" next to it.
4. Press ★ button for two seconds and favourite position is saved.

Note:

Favourite positions 3 and 4 can be disabled via the DPG configurator (from DPG SW ver. 1.29).

Driving to favourite positions

After saving the favourite positions, the user can reach the positions simply by tilting/pressing the DPG1C.

1. Tilt/press and hold - when a saved position has been reached, the desk stops.
2. Release DPG1C within one second.

This way the user can easily change between sitting and standing height without looking at the DPG1C in the meantime. During desk driving, the display will show the height of the desk. When a favourite position has been reached, the display shows a ★ and the position number.

The DPG1C stops at all saved favourite positions, which means up to four different positions during the stroke length of the desk.

When the desk stops at a favourite position, the user can

- keep tilting/pressing the DPG1C for more than one second
or
- release the DPG1C and immediately tilt/press it again.

The desk will move past the favourite position and continue its movement.



Figure 36: Tilt/press to drive desk

Automatic driving to favourite positions

(only possible for "Full version" with "Automatic drive" enabled in the Desk Control™ App)

1. Double-tap DPG1C to let desk adjust automatically to first position in direction of double-tap.
2. To stop driving of desk between two favourite positions, simply tap DPG1C once.



Figure 37: Double-tap to automatically adjust the desk to a favourite position

Erasing favourite positions

1. Press the ★ button for eight seconds to erase all saved favourite positions.

After five seconds, the display shows a countdown, and the light strip flashes red when all the favourite positions are erased.



Figure 38: Erase favourite positions

Bluetooth®

Connecting Bluetooth®

1. The apps are called "Desk Control™" and they have the following app logo in iTunes and Apple App store, Google Play store, and Microsoft Store::



2. Press **⌘** button in the middle for two seconds to enable pairing mode.

The display on the DPG1C will inform about the Bluetooth® ID of the desk, which is "DESK" followed by a four-digit number – look for this ID in the list of "Desks nearby" in the Desk Control™ App.

The light strip flashes blue while the desk panel is in pairing mode.



Figure 39: Connect Bluetooth®

Reminder

The reminder LED lights through the surface of the DPG1C. The light is intended to indicate the position of the desk (sitting or standing height). The indication depends on the reminder interval chosen.

Heartbeat (light strip)

The heartbeat reminder is shown as a thin LED light strip. While the user is sitting for an appropriate amount of time according to the set interval, the light strip calmly pulsates green symbolising a heartbeat. When the sitting interval runs out, the calm pulsating green turns into fast pulsating orange for one minute hereafter into static orange to indicate that the user should adjust the desk to standing height. In standing height, the light strip pulsates green until a potential timeout (standard timeout is four hours). When the desk is adjusted back to sitting height, the light strip pulsates green until the reminder goes off again.

Reminder restart

The reminder automatically restarts when the desk is adjusted to sitting height.

Reminder timeout

After four hours without any action, the light strip will time out. When the DPG1C is tilted, the green light turns back on.



When the light (strip or blocks) is enabled for reminders, the DPG1C is no longer in ZERO™ mode as long as the light is on/active.



Reminder intervals

The number of white blocks (one, two or three) each representing an interval. The three standard intervals are:

- Interval 1: Reminder after 55 minutes sitting
- Interval 2: Reminder after 50 minutes sitting
- Interval 3: Reminder after 45 minutes sitting

The default interval is reminding after 55 minutes, which means one white block lights up.

Adjusting the reminder interval

1. Press  button to adjust interval of getting reminded to change position.
2. Toggle through intervals by pressing  button.
3. Release  button when desired interval is indicated.

When no white blocks are lit up, the reminder is turned off.

Through the app, it is possible to personalise the three intervals to custom values.



Interval 1: Reminder after 55 minutes sitting



Interval 2: Reminder after 50 minutes sitting



Interval 3: Reminder after 45 minutes sitting



Reminder off

Figure 40: Set the reminder

Resetting the reminder

1. Press  symbol for eight seconds to reset reminder to default values.

After five seconds the display shows a countdown and the light strip flashes red when the reminder is reset.





Figure 41: Reset reminder

Key lock

The operation of DPG1C can be locked to prevent unintended driving of the desk. As default the key lock is disabled. If enabled, it automatically locks the DPG1C after a configured amount of time. The key lock function can also be configured to indicate attempt to operate the locked DPG1C by showing a red light and a .

Unlocking DPG1C

1. Press ,  and  in sequence (max. one second between each button press).

Troubleshooting/FAQs

Error codes (only DPG1C)



The DPG1C shows error codes generated in the CBD6S in case of errors in the system. The most common errors loop between the error code (EXX) and the error text, check the codes below:

Error codes	Cause
E53-E64	COLLISION
E41-E52	OVERLOAD
E01	INITIALISATION



Software versions before SW 1.13 only show error E01.

Factory reset (only DPG1M, DPG1B and DPG1C)

Press and hold the  and  buttons for eight seconds to set the DPG to factory default. The LED/light strip flashes red three times to indicate the reset is done. If a factory reset is performed, it sets the DPG back to the configured state, i.e. all configurations made in the DPG configurator will not be reset – only the settings changed directly on the DPG or in the app by the end users will be reset.

DPG1C only

During reset, the display lights up after five seconds, showing an arrow with a countdown [seconds] and RESET



Figure 42: Reset to factory default (DPG1B and DPG1C)



Figure 43: Reset to factory default (DPG1M)

Important information

Important information on LINAK® products can be found under the following headings:



Warning!

Failure to comply with these instructions may result in accidents involving serious personal injury.



Failing to follow these instructions can result in the product being damaged or being destroyed.

Safety instruction



General

Safe use of the system is possible only when the operating instructions are read completely and the instructions contained are strictly observed.

Failure to comply with instructions marked with the "NOTE" symbol may result in serious damage to the system or one of its components.



It is important for everyone who is to connect, install, or use the systems to have the necessary information and access to this User Manual. Follow the instructions for mounting – risk of injury if these instructions are not followed.



The appliance is not intended for use by young children or infirm persons without supervision.



If there is visible damage on the product it must not be installed.



Note that during construction of applications, in which the actuator is to be fitted, there must be no possibility of personal injury, for example the squeezing of fingers or arms.



Assure free space for movement of application in both directions to avoid blockade.

This device complies with part 15 of the FCC Rules. Operation is subject to the following two conditions:

- (1) This device may not cause harmful interference, and**
- (2) This device must accept any interference received, including interference that may cause undesired operation**

- **Statement – for all intentional and unintentional radiators:**

Changes or modifications not expressly approved by the party responsible for compliance could void the user's authority to operate the equipment.

- **Statement for digital devices for Class B:**

NOTE: This equipment has been tested and found to comply with the limits for a Class B digital device, pursuant to part 15 of the FCC Rules. These limits are designed to provide reasonable protection against harmful interference in a residential installation. This equipment generates, uses and can radiate radio frequency energy and, if not installed and used in accordance with the instructions, it may cause harmful interference to radio communications. However, there is no guarantee that interference will not occur in a particular installation. If this equipment does cause harmful interference to radio or television reception, which can be determined by turning the equipment off and on, the user is encouraged to try to correct the interference by one or more of the following measures:

- Reorient or relocate the receiving antenna.
 - Increase the separation between the equipment and the receiver.
 - Connect the equipment into an outlet on a circuit different from that to which the receiver is connected.
 - Consult the dealer or an experienced radio/ TV technician for help.
-

This device contains licence-exempt transmitter(s)/receiver(s) that comply with Innovation, Science and Economic Development Canada's licence-exempt RSS(s). Operation is subject to the following two conditions:

- (1) This device may not cause interference.
- (2) This device must accept any interference, including interference that may cause undesired operation of the device.

L'émetteur/récepteur exempt de licence contenu dans le présent appareil est conforme aux CNR d'Innovation, Sciences et Développement économique Canada applicables aux appareils radio exempts de licence. L'exploitation est autorisée aux deux conditions suivantes:

- (1) L'appareil ne doit pas produire de brouillage;
 - (2) L'appareil doit accepter tout brouillage radioélectrique subi, même si le brouillage est susceptible d'en compromettre le fonctionnement.
-

Labeling Requirements:

This Class B digital apparatus complies with Canadian ICES-003.

Cet appareil numérique de la classe B est conforme à la norme NMB-003 du Canada.

Only for EU markets



This appliance can be used by children aged from 8 years and above and persons with reduced physical, sensory or mental capabilities or lack of experience and knowledge if they have given supervision or instruction concerning the use of the appliance in a safe way and understand the hazards involved.



Children shall not play with the appliance. Cleaning and user maintenance shall not be made by children without supervision.

Only for Non EU markets



Persons who do not have the necessary experience or knowledge of the product/products must not use the product/products. Besides, persons with reduced physical, sensory or mental abilities must not use the product/products, unless they are under surveillance or they have been thoroughly instructed in the use of the apparatus by a person who is responsible for the safety of these persons.



Moreover, children must be under surveillance to ensure that they do not play with the product.

Misuse



Do not overload the actuators – this can cause danger of personal injury and damage to the system.



Do not use the actuator system for lifting persons. Do not sit or stand on a table while operating – risk of personal injury.



Do not use the system in environments other than the intended indoor use.

Repairs

In order to avoid the risk of malfunction, all DESKLINE® repairs must only be carried out by authorised LINAK service centres or repairers, as special tools must be used and special gaskets must be fitted. Products under warranty must also be returned to authorised LINAK service centres.

Further information on DESKLINE warranty can be found on the LINAK website www.linak.com/warranty.



Warning!

If any of the DESKLINE® products are opened, there will be a risk of subsequent malfunction.



Warning!

The DESKLINE® systems are not resistant to cutting oil.

Manufacturer's declaration

DECLARATION OF INCORPORATION OF PARTLY COMPLETED MACHINERY

LINAK A/S
Smedevænget 8
DK - 6430 Nordborg

Herewith declares that LINAK DESKLINE® products as characterized by the following models and types:

Control Boxes: CBD6Sa000b0A-c09 (Where -a: can be P, C or H, -b: can be 2, 3 or 4 and -c: can be 0 or 7)

Linear Actuators: LA31

Built in actuator(s): DB5, DB6, DB14,

Lifting Columns: DL1A, DL4S, DL2, DL5, DL6, DL7, DL8, DL9, DL10, DL11, DL12, DL14, DL15, DL16, DL17, DL18, DL19, DL20, DL21

Desk Panels: DPA, DPB, DPH, DPF1K, DPF1M, DPF2K, DPF3K, DPF1C, DPF1D, DPF1U, DPF1W, DPF4T, DPG1K, DPG1M, DPG1B, DPG1C, DPT, DP1V01, DP1CS, DP1K, DP1U, DP2K, DP3K, DPN, DPWA

Accessories: BLE2LIN002, BLE2LIN003, DESK SENSOR 1, USB2LIN, DCCconnector

complies with the following parts of the Machinery Directive 2006/42/EC, ANNEX I, *Essential health and safety requirements relating to the design and construction of machinery:*

- 1.1.2 a) Special use*
- 1.1.2 b) Selection of the most appropriate methods*
- 1.1.2 c) Foreseeable misuse*
- 1.1.2 d) Operator constraints due to the use of personal protective equipment*

1.1.3 Materials and products*

- 1.2.1 Safety and reliability of control systems
- 1.2.2 Control devices. Shape, readability, overview*
- 1.2.3 Stopping*
- 1.2.4 Stopping*

- 1.5.1 Electricity supply
- 1.5.10 Radiation, EMC. Emission of electromagnetic radiation, X-rays, γ -rays*
- 1.5.11 External radiation*

*need to be further evaluated in the end product

We confirm that prior to market introduction the relevant technical documentation is compiled in accordance with part B of Annex VII and the assembly instruction pursuant to Annex VI.

This documentation or part hereof will be transmitted by post or electronically to a reasoned request by the national authorities.

The products mentioned in this document are to be combined for use in height adjustable furniture.

This partly completed machinery must not be put into service until the final machinery into which it is to be incorporated has been declared in conformity with the provisions of the Machinery Directive 2006/42/EC where appropriate.

Nordborg, 2020-10-28

LINAK A/S
Dragan Macura,
Regulatory Compliance Manager
Deskline and Hicroline Segments
Authorized to compile the relevant technical documentation

Original Declaration

DECLARATION OF CONFORMITY

LINAK A/S
Smedevænget 8
DK - 6430 Nordborg

hereby declares that LINAK Bluetooth handset
HC4aBLbcSddee00-f
(Where - a can be 2, 3 or 4; - b can be 0 or 1; - c can be 0 or 1; - dd can be 00 or 01; - ee can be 00, 01, 02, x-; - f can be any letter)

complies with the Radio Equipment Directive 2014/53/EU according to following standards:
EN 300328 V2.1.1-2016,
EN 301489-1 V2.2.0:2017, EN 301489-17 V3.2.0:2017
EN 62479:2010,
EN 62368-1:2014+A11:2017

complies with RoHS2 Directive 2011/65/EU according to following standards:
EN 50581:2012

Nordborg, 2019-09-26

LINAK A/S
John Kling, B.Sc.E.E.
Regulatory Affairs Manager
Authorized to compile the relevant technical documentation

Original Declaration

Use the BLE2LIN in an environment with temperature between -10 and +50 °C. Otherwise, the BLE2LIN may be damaged. It can be operated at altitudes up to 2000 m.

Hereby, LINAK A/S declares that the radio equipment type BLE2LIN is compliant with Directive 2014/53/EU.



The equipment is a Bluetooth® Adapter powered by 9 V DC or 18 V input charged by an RJ45 port.

Operating Frequency Range
Bluetooth® 2402 - 2480 MHz

The maximum RF Output Power
-9.81 dBm EIRP

iWOW Electric Lift Height Controller Instructions

Technical specifications & Instructions for use

Misc. on the DESKLINE® system

Warranty

This DESKLINE product is subject to warranty pursuant to the terms of LINAK DESKLINE Warranty Paper, available on the LINAK website www.linak.com/warranty.

Maintenance

Clean dust and dirt from the outside of the system at appropriate intervals and inspect for damage and breaks. Inspect connections, cables, and plugs without disconnecting, and check functioning as well as fixing points.

Cleaning the desk panel

Clean your desk panel with a soft damp cloth. Universal cleaning detergents may be used.

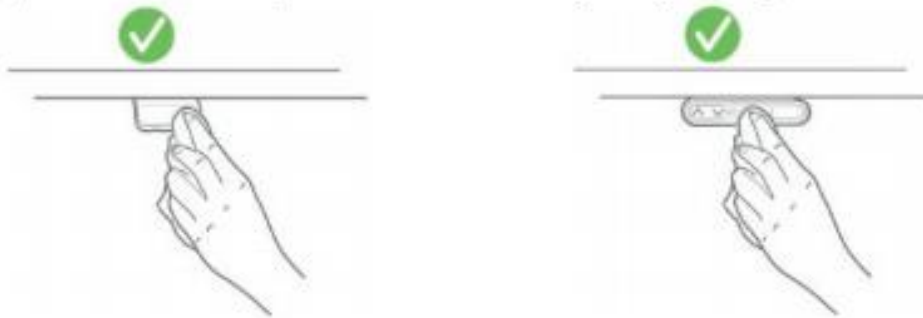

For disinfection of the desk panel, use a 70 percent isopropyl alcohol either as a wipe or add a small amount to a soft cloth.



The desk panel is not a sealed unit and there are electronics inside it. If liquids or moisture enter an opening, the PCB may be damaged, and the desk panel ruined.

Thus:

- Avoid moisture penetrating any openings as this may damage the PCB inside the desk panel
- Avoid spraying the cleaning agent or disinfectant directly on the desk panel as moisture may penetrate openings damaging the PCB inside the desk panel



- Cleaning agents and disinfectants must not be highly alkaline or acidic (pH value must be 6 to 8), and they must not contain bleach or chlorine
- Do not use hand sanitizer gel as a cleaning agent

ETL-marking

Due to space limitations, the complete ETL-marking demands are not represented on the marking plates. The full ETL Recognized Component markings are shown here.



C/N 120690

Conforms to ANSI/AAMI Std. E580601-1
Cert. to CSA Std. C22.2 No. 60601-1

ETL Recognized Component mark for Canada and United States



C/N 4008003

Conforms to ANSI/AAMI Std. E580601-1
Cert. to CSA Std. C22.2 No. 60601-1

ETL Recognized Component mark for Canada and United States



C/N 4008004

Conforms to ANSI/AAMI Std. E580601-1
Cert. to CSA Std. C22.2 No. 60601-1

ETL Recognized Component mark for Canada and United States



C/N 9901916

Conforms to ANSI/AAMI Std. E580601-1
Cert. to CSA Std. C22.2 No. 60601-1

ETL Recognized Component mark for Canada and United States



C/N 4008671

Conforms to UL962
Cert. to CSA Std. C22.2 No. 68-09

ETL Recognized Component mark for Canada and United States

iWOW Electric Lift Height Controller Instructions

Technical specifications & Instructions for use

DPG1C with cover

